

For reference only. See data sheet for the detailed specifications.

Technical Specification



Frequency Range(GHz)	8.0 – 18.0
Gain(dBi)	5 Typ.
Polarization	Linear
VSWR	2.0:1 Typ.
Output	SMA-Female
Power Handling(W CW)	80 Max.
Material	Al
Size(mm)	110 x 110 x 71
Net Weight(Kg)	0.50 Around

PATENT ID (China)

ZL202220803839.9, ZL201630458448.8

Outline Drawing (Size: mm)

SMA-Female Output (P/N: PZ-8001800/P)

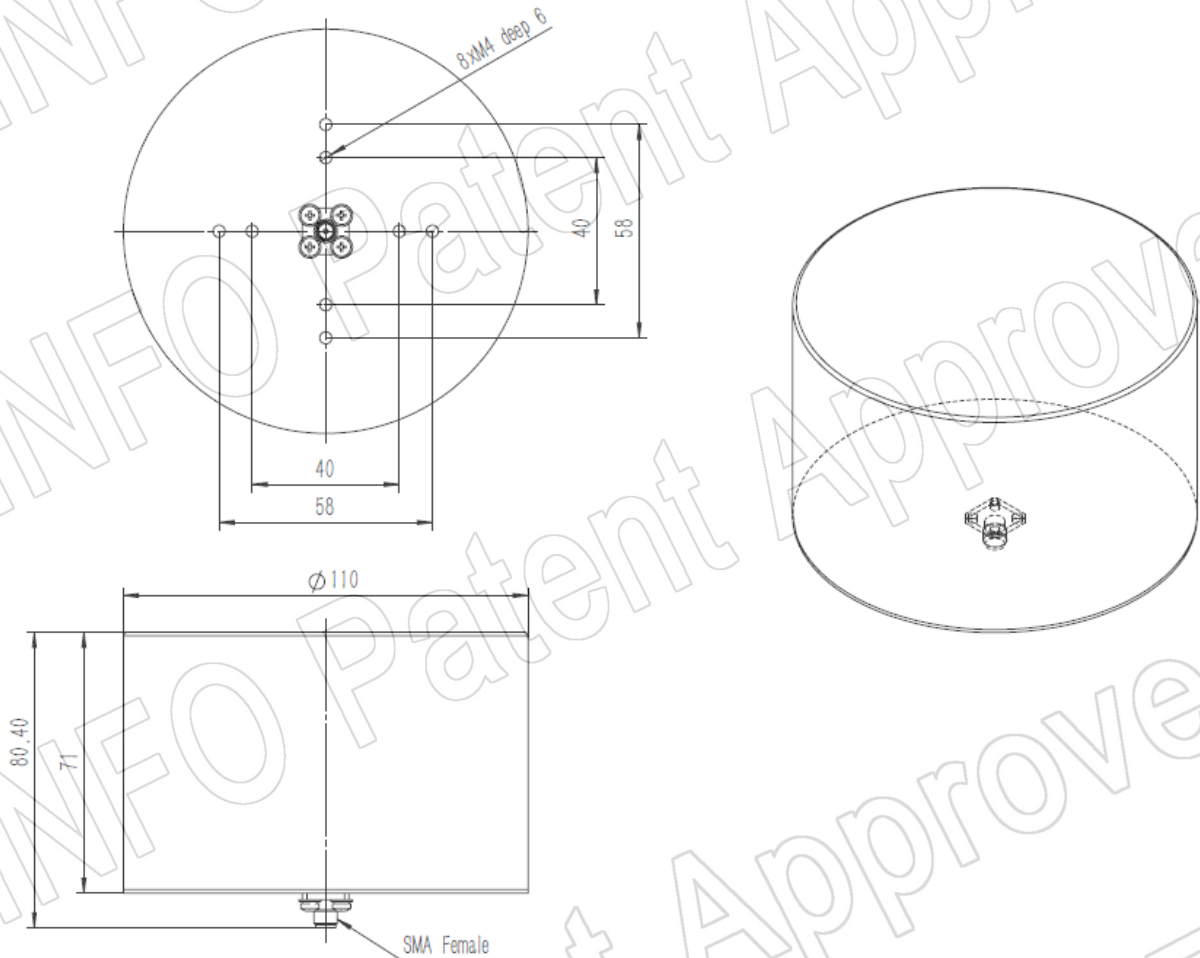

AINFO Inc.

Page 1 of 8

China(Beijing):
China(Chengdu):
USA :

Tel: (+86) 10-6266-7326,
Tel: (+86) 28-8519-2786,
Tel: (+1) 949-639-9688,

(+86) 10-6266-7327
(+86) 28-8519-3044
(+1) 949-639-9608

Fax: (+86) 10-6266-7379
Fax: (+86) 28-8519-3068
Fax: (+1) 949-639-9670

Website: www.ainfoinc.com
Email: sales@ainfoinc.com

SMA-Female Output with Round Type Mounting Bracket (Option, P/N: SZ-2001800/P-MB2, Tripod Application)

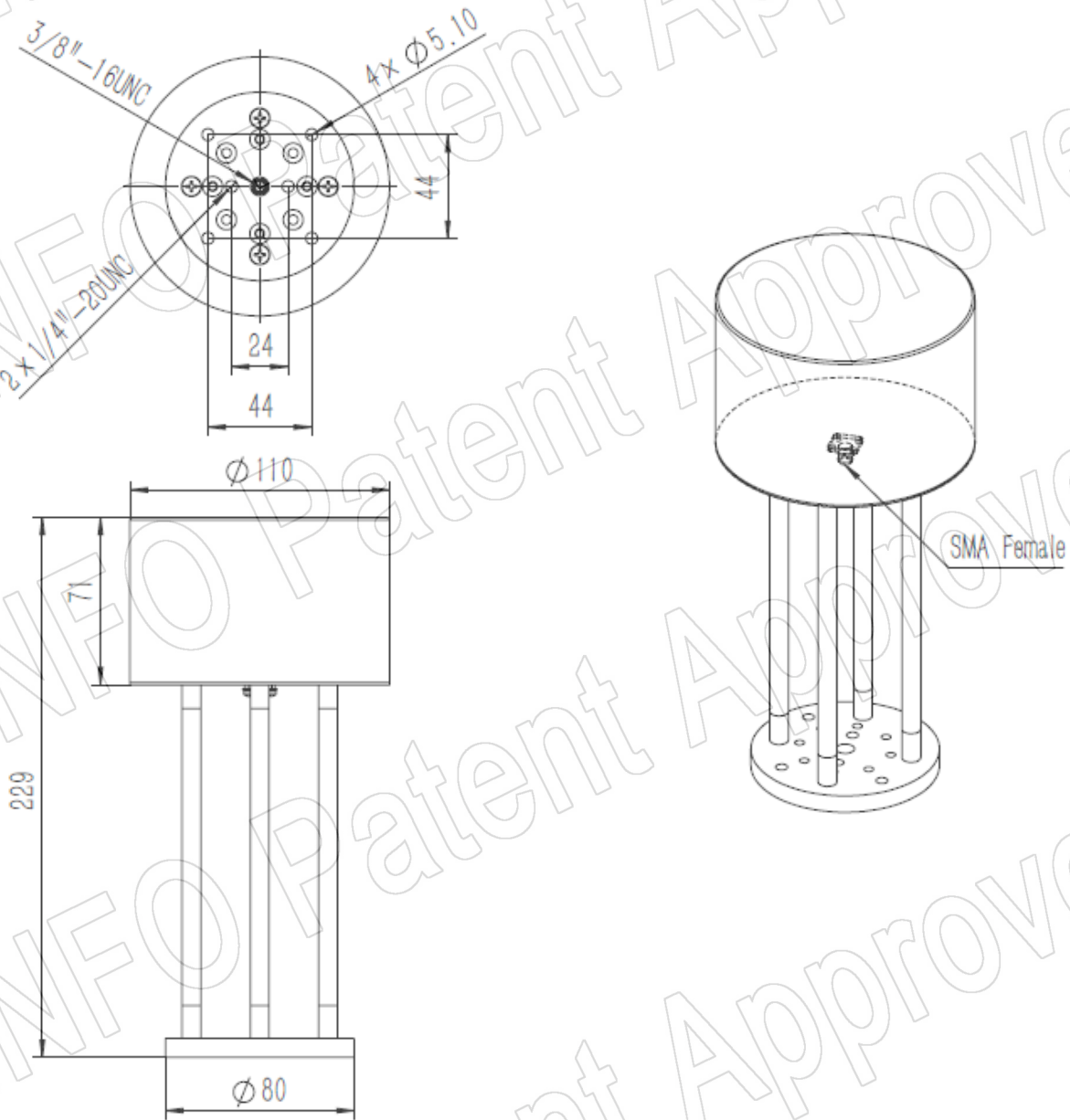

Test Results

1. Gain & Antenna Factor

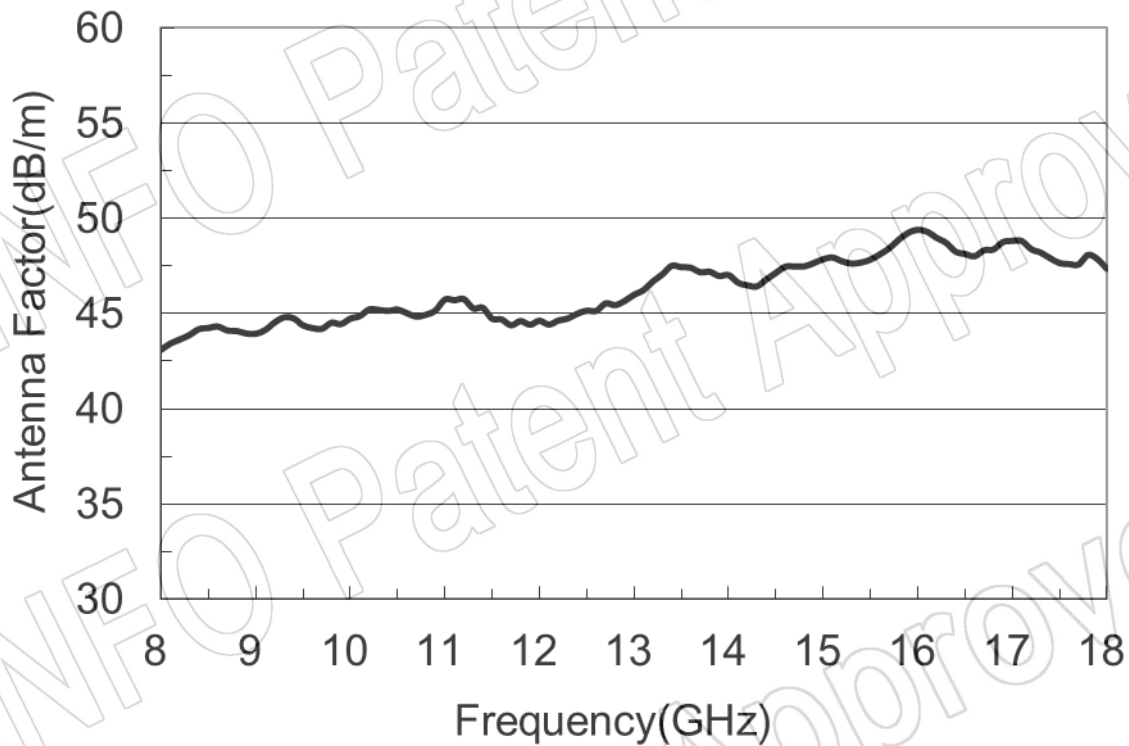
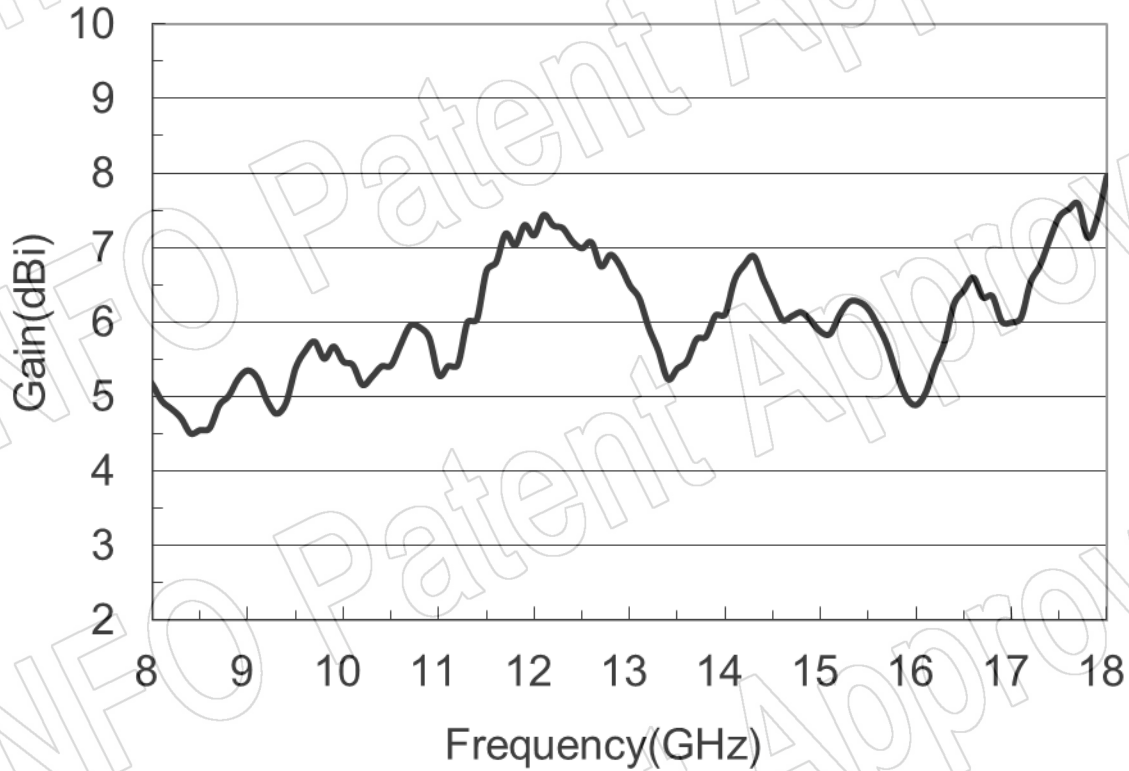

2. VSWR

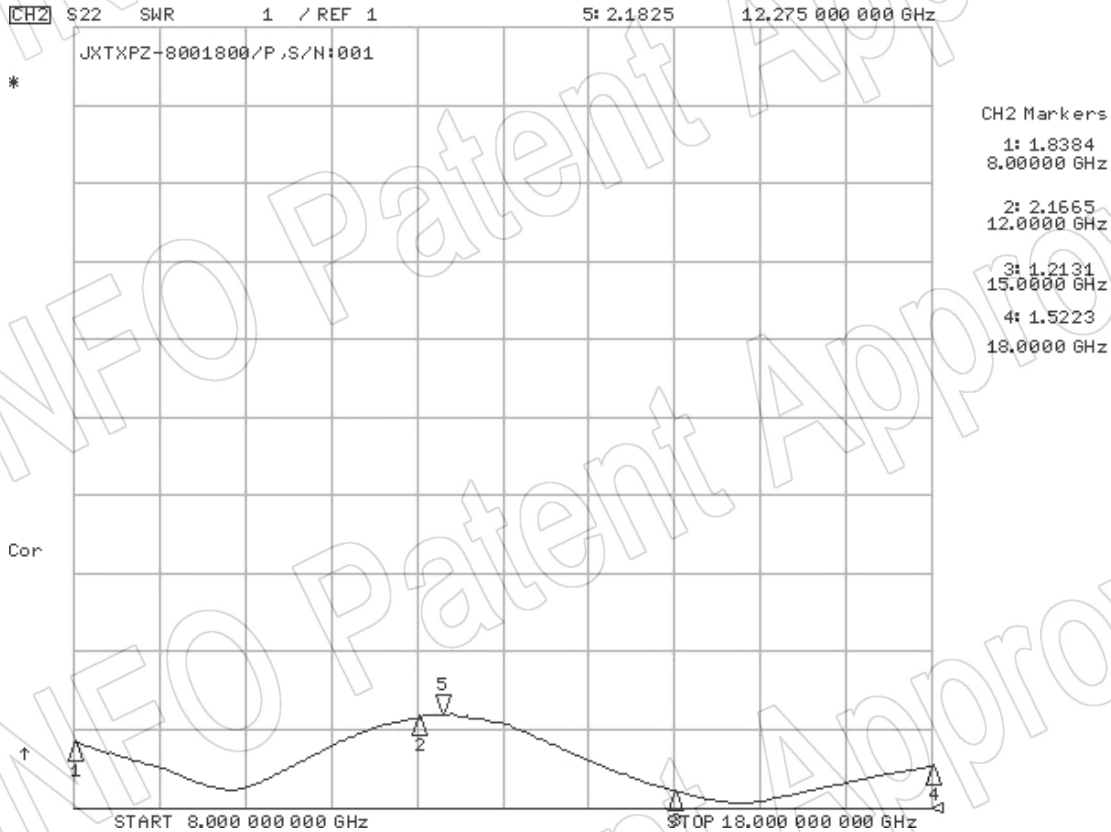

3. Pattern

